



## Operation/Reference Guide

# MXT/D-1900L-PAN

19.4" Modero® X Series Panoramic Tabletop Touch Panel

19.4" Modero® X Series Panoramic Wall Touch Panel



# AMX Limited Warranty and Disclaimer

This Limited Warranty and Disclaimer extends only to products purchased directly from AMX or an AMX Authorized Partner which include AMX Dealers, Distributors, VIP's or other AMX authorized entity.

AMX warrants its products to be free of defects in material and workmanship under normal use for three (3) years from the date of purchase, with the following exceptions:

- Electroluminescent and LCD Control Panels are warranted for three (3) years, except for the display and touch overlay components are warranted for a period of one (1) year.
- Disk drive mechanisms, pan/tilt heads, power supplies, and MX Series products are warranted for a period of one (1) year.
- AMX lighting products are guaranteed to switch on and off any load that is properly connected to our lighting products, as long as the AMX lighting products are under warranty. AMX also guarantees the control of dimmable loads that are properly connected to our lighting products. The dimming performance or quality there of is not guaranteed, impart due to the random combinations of dimmers, lamps and ballasts or transformers.
- AMX software is warranted for a period of ninety (90) days.
- Batteries and incandescent lamps are not covered under the warranty.
- AMX AutoPatch Epica, Modula, Modula Series4, Modula CatPro Series and 8Y-3000 product models will be free of defects in materials and manufacture at the time of sale and will remain in good working order for a period of three (3) years following the date of the original sales invoice from AMX. The three-year warranty period will be extended to the life of the product (Limited Lifetime Warranty) if the warranty card is filled out by the dealer and/or end user and returned to AMX so that AMX receives it within thirty (30) days of the installation of equipment but no later than six (6) months from original AMX sales invoice date. The life of the product extends until five (5) years after AMX ceases manufacturing the product model. The Limited Lifetime Warranty applies to products in their original installation only. If a product is moved to a different installation, the Limited Lifetime Warranty will no longer apply, and the product warranty will instead be the three (3) year Limited Warranty.

All products returned to AMX require a Return Material Authorization (RMA) number. The RMA number is obtained from the AMX RMA Department. The RMA number must be clearly marked on the outside of each box. The RMA is valid for a 30-day period. After the 30-day period the RMA will be cancelled. Any shipments received not consistent with the RMA, or after the RMA is cancelled, will be refused. AMX is not responsible for products returned without a valid RMA number.

AMX is not liable for any damages caused by its products or for the failure of its products to perform. This includes any lost profits, lost savings, incidental damages, or consequential damages. AMX is not liable for any claim made by a third party or by an AMX Authorized Partner for a third party.

This Limited Warranty does not apply to (a) any AMX product that has been modified, altered or repaired by an unauthorized agent or improperly transported, stored, installed, used, or maintained; (b) damage caused by acts of nature, including flood, erosion, or earthquake; (c) damage caused by a sustained low or high voltage situation or by a low or high voltage disturbance, including brownouts, sags, spikes, or power outages; or (d) damage caused by war, vandalism, theft, depletion, or obsolescence.

This limitation of liability applies whether damages are sought, or a claim is made, under this warranty or as a tort claim (including negligence and strict product liability), a contract claim, or any other claim. This limitation of liability cannot be waived or amended by any person. This limitation of liability will be effective even if AMX or an authorized representative of AMX has been advised of the possibility of any such damages. This limitation of liability, however, will not apply to claims for personal injury.

Some states do not allow a limitation of how long an implied warranty last. Some states do not allow the limitation or exclusion of incidental or consequential damages for consumer products. In such states, the limitation or exclusion of the Limited Warranty may not apply. This Limited Warranty gives the owner specific legal rights. The owner may also have other rights that vary from state to state. The owner is advised to consult applicable state laws for full determination of rights.

EXCEPT AS EXPRESSLY SET FORTH IN THIS WARRANTY, AMX MAKES NO OTHER WARRANTIES, EXPRESSED OR IMPLIED, INCLUDING ANY IMPLIED WARRANTIES OF MERCHANTABILITY OR FITNESS FOR A PARTICULAR PURPOSE. AMX EXPRESSLY DISCLAIMS ALL WARRANTIES NOT STATED IN THIS LIMITED WARRANTY. ANY IMPLIED WARRANTIES THAT MAY BE IMPOSED BY LAW ARE LIMITED TO THE TERMS OF THIS LIMITED WARRANTY. EXCEPT AS OTHERWISE LIMITED BY APPLICABLE LAW, AMX RESERVES THE RIGHT TO MODIFY OR DISCONTINUE DESIGNS, SPECIFICATIONS, WARRANTIES, PRICES, AND POLICIES WITHOUT NOTICE.

# AMX Software License and Warranty Agreement

- **LICENSE GRANT.** AMX grants to Licensee the non-exclusive right to use the AMX Software in the manner described in this License. The AMX Software is licensed, not sold. This license does not grant Licensee the right to create derivative works of the AMX Software. The AMX Software consists of generally available programming and development software, product documentation, sample applications, tools and utilities, and miscellaneous technical information. Please refer to the README.TXT file on the compact disc or download for further information regarding the components of the AMX Software. The AMX Software is subject to restrictions on distribution described in this License Agreement. AMX Dealer, Distributor, VIP or other AMX authorized entity shall not, and shall not permit any other person to, disclose, display, loan, publish, transfer (whether by sale, assignment, exchange, gift, operation of law or otherwise), license, sublicense, copy, or otherwise disseminate the AMX Software. Licensee may not reverse engineer, decompile, or disassemble the AMX Software.
- **ACKNOWLEDGEMENT.** You hereby acknowledge that you are an authorized AMX dealer, distributor, VIP or other AMX authorized entity in good standing and have the right to enter into and be bound by the terms of this Agreement.
- **INTELLECTUAL PROPERTY.** The AMX Software is owned by AMX and is protected by United States copyright laws, patent laws, international treaty provisions, and/or state of Texas trade secret laws. Licensee may make copies of the AMX Software solely for backup or archival purposes. Licensee may not copy the written materials accompanying the AMX Software.
- **TERMINATION.** AMX RESERVES THE RIGHT, IN ITS SOLE DISCRETION, TO TERMINATE THIS LICENSE FOR ANY REASON UPON WRITTEN NOTICE TO LICENSEE. In the event that AMX terminates this License, the Licensee shall return or destroy all originals and copies of the AMX Software to AMX and certify in writing that all originals and copies have been returned or destroyed.
- **PRE-RELEASE CODE.** Portions of the AMX Software may, from time to time, as identified in the AMX Software, include PRE-RELEASE CODE and such code may not be at the level of performance, compatibility and functionality of the GA code. The PRE-RELEASE CODE may not operate correctly and may be substantially modified prior to final release or certain features may not be generally released. AMX is not obligated to make or support any PRE-RELEASE CODE. ALL PRE-RELEASE CODE IS PROVIDED "AS IS" WITH NO WARRANTIES.
- **LIMITED WARRANTY.** AMX warrants that the AMX Software (other than pre-release code) will perform substantially in accordance with the accompanying written materials for a period of ninety (90) days from the date of receipt. AMX DISCLAIMS ALL OTHER WARRANTIES, EITHER EXPRESS OR IMPLIED, INCLUDING, BUT NOT LIMITED TO IMPLIED WARRANTIES OF MERCHANTABILITY AND FITNESS FOR A PARTICULAR PURPOSE, WITH REGARD TO THE AMX SOFTWARE. THIS LIMITED WARRANTY GIVES LICENSEE SPECIFIC LEGAL RIGHTS. Any supplements or updates to the AMX SOFTWARE, including without limitation, any (if any) service packs or hot fixes provided to Licensee after the expiration of the ninety (90) day Limited Warranty period are not covered by any warranty or condition, express, implied or statutory.
- **LICENSEE REMEDIES.** AMX's entire liability and Licensee's exclusive remedy shall be repair or replacement of the AMX Software that does not meet AMX's Limited Warranty and which is returned to AMX in accordance with AMX's current return policy. This Limited Warranty is void if failure of the AMX Software has resulted from accident, abuse, or misapplication. Any replacement AMX Software will be warranted for the remainder of the original warranty period or thirty (30) days, whichever is longer. Outside the United States, these remedies may not be available. NO LIABILITY FOR CONSEQUENTIAL DAMAGES. IN NO EVENT SHALL AMX BE LIABLE FOR ANY DAMAGES WHATSOEVER (INCLUDING, WITHOUT LIMITATION, DAMAGES FOR LOSS OF BUSINESS PROFITS, BUSINESS INTERRUPTION, LOSS OF BUSINESS INFORMATION, OR ANY OTHER PECUNIARY LOSS) ARISING OUT OF THE USE OF OR INABILITY TO USE THIS AMX SOFTWARE, EVEN IF AMX HAS BEEN ADVISED OF THE POSSIBILITY OF SUCH DAMAGES. BECAUSE SOME STATES/COUNTRIES DO NOT ALLOW THE EXCLUSION OR LIMITATION OF LIABILITY FOR CONSEQUENTIAL OR INCIDENTAL DAMAGES, THE ABOVE LIMITATION MAY NOT APPLY TO LICENSEE.
- **U.S. GOVERNMENT RESTRICTED RIGHTS.** The AMX Software is provided with RESTRICTED RIGHTS. Use, duplication, or disclosure by the Government is subject to restrictions as set forth in subparagraph ©(1)(ii) of The Rights in Technical Data and Computer Software clause at DFARS 252.227-7013 or subparagraphs ©(1) and (2) of the Commercial Computer Software Restricted Rights at 48 CFR 52.227-19, as applicable.
- **SOFTWARE AND OTHER MATERIALS FROM AMX.COM MAY BE SUBJECT TO EXPORT CONTROL.** The United States Export Control laws prohibit the export of certain technical data and software to certain territories. No software from this Site may be downloaded or exported (i) into (or to a national or resident of) Cuba, Iraq, Libya, North Korea, Iran, Syria, or any other country to which the United States has embargoed goods; or (ii) anyone on the United States Treasury Department's list of Specially Designated Nationals or the U.S. Commerce Department's Table of Deny Orders. AMX does not authorize the downloading or exporting of any software or technical data from this site to any jurisdiction prohibited by the United States Export Laws.

**This Agreement replaces and supersedes all previous AMX Software License Agreements and is governed by the laws of the State of Texas, and all disputes will be resolved in the courts in Collin County, Texas, USA. For any questions concerning this Agreement, or to contact AMX for any reason, please write: AMX License and Warranty Department, 3000 Research Drive, Richardson, TX 75082.**



# Table of Contents

<b>Modero X® Series Touch Panels</b> .....	<b>1</b>
Overview .....	1
Features.....	1
Modero X Dealer Benefits .....	1
Modero X Customer Benefits .....	1
MXT-1900L-PAN .....	2
Connector Locations .....	5
Memory.....	5
Basic Operation.....	5
Powering on the MXT-1900L-PAN .....	5
Microphone .....	5
Audio/Video Capabilities .....	5
MXT-1900L-PAN-NC .....	5
MXD-1900L-PAN .....	6
Memory.....	8
Basic Operation.....	8
Powering on the MXD-1900L-PAN.....	8
Microphone .....	8
Audio/Video Capabilities .....	8
MXD-1900L-PAN-NC .....	9
MXD/T-1900L-PAN Features .....	9
Picture View .....	9
Preview Mode and Normal Mode .....	10
Picture View Send Command .....	11
Configuration .....	11
Bluetooth Support .....	11
NFC.....	11
Cleaning the Touch Overlay and Case.....	12
<b>Installation</b> .....	<b>13</b>
MXT-1900L-PAN Installation .....	13
Wiring Guidelines .....	13
Wiring a Power Connection.....	14
A Note About Wall and Rack Installation.....	15
Installation Recommendations .....	16
MXD-1900L-PAN Installation .....	16
Installing the MXD-1900L-PAN into a wall .....	16
Wiring a Power Connection.....	22

- Configuration and Programming .....23**
  - Modero X Series Programming Guide ..... 23
- Upgrading Firmware .....25**
  - Overview ..... 25
  - Upgrading Firmware via USB Flash Drive ..... 25
    - Load the Firmware on a USB Flash Drive ..... 25
    - Transfer the Firmware File From the Flash Drive to the Touch Panel..... 26
  - Upgrading from Previous Firmware ..... 27
  - Returning to Factory Default Firmware ..... 27
  - Upgrading Firmware Via NetLinx Studio ..... 28
    - Viewing devices on the Virtual System..... 30
    - Downloading Firmware ..... 30
- Appendix: Troubleshooting .....33**
  - Overview ..... 33
  - Panel Doesn't Respond To Touches ..... 33
  - Panel Isn't Appearing In The Online Tree Tab ..... 33
  - Can't Connect To a NetLinx Master ..... 33
  - Only One Modero Panel In My System Shows Up ..... 33

# Modero X® Series Touch Panels

## Overview

See more and do more with the most elegant interface designed specifically for dedicated room control. The Modero X® Series Touch Panels provide several industry firsts, including a beautiful, panoramic capacitive multi-touch screen that provides users access to multiple applications with minimal navigation. It is hardware-ready for support of Near Field Communication™ (NFC) Technology, to allow personalization of the user experience and productivity enhancing capabilities through integration with NFC capable personal devices. The distinctive, low-profile design is engineered to sit perfectly on a table without obstructing views. Modero X Series is the control surface that simply delivers more.

## Features

- **Panoramic Control Surface** – Combined with the new PanTastic UI, the panoramic touch panels take the user experience to a whole new level with an impressive control surface to perform activities much in the same way you use a computer – multi-tasking with dedicated spaces.
- **Future Technology Visions** – HD video chat and conferencing using integrated camera and hardware - ready to support Near Field Communication (NFC) Technology, which promises short-range wireless technologies that deliver peer-to-peer communication by 'sharing, pairing and transaction' between RF devices like exchanging data/identities.
- **Enhanced Usability** – External phone connections via Bluetooth or USB and HD video streaming.
- **Graphic Leaps & Bounds** – The Modero X Series includes some striking new intuitive UI functionality including: gesturing, swiping, dynamic reordering and enhanced animation capabilities
- **Perfect From Any Angle** – Includes In-Plane Switching (IPS), the latest technology in popular tablet/mobile devices that delivers the widest viewing angles and the most accurate color reproduction on the market.

## Modero X Dealer Benefits

- **Attract More Corporate Customers** - The elegant design and simple beauty of the Modero X Series will create demand from both new and current customers.
- **Address Unique Requirements** – With a panoramic profile, the Modero X Series provides dealers with a solution for uses where multiple applications must be viewed simultaneously.
- **Differentiate Yourself** – The Modero X Series offers design and technology features unmatched in the industry.

## Modero X Customer Benefits

- **Multi-Task Capability** – The contemporary design provides a large control surface, which allows multiple views for different activities such as presenting, controlling and previewing.
- **Simple to Use Interfaces** – The capacitive multi-touch screen combined with intuitive user-interfaces makes it easy for anyone to operate sophisticated meeting room equipment
- **Sleek, Low-Profile Design** - The Modero X Series is engineered to sit perfectly on a table without obstructing views.

## MXT-1900L-PAN

The MXT-1900L-PAN (FG5968-02) (FIG. 1) is ideal for boardrooms, conference rooms, or auditoriums where a panoramic control surface is needed to provide access to multiple functions simultaneously while remaining elegantly unobtrusive. In residences, it is perfect for kitchens, home theaters, or home offices where the panoramic control surface can be used to manage systems throughout the house.

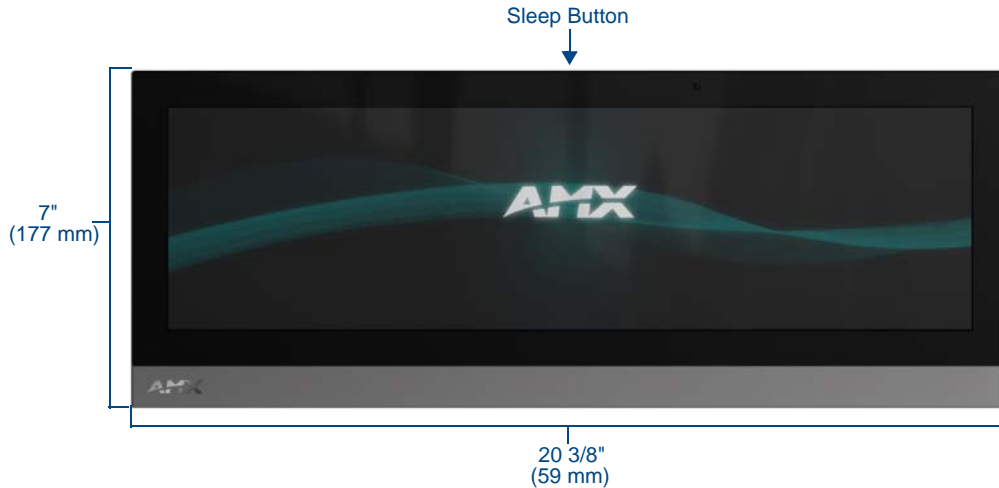
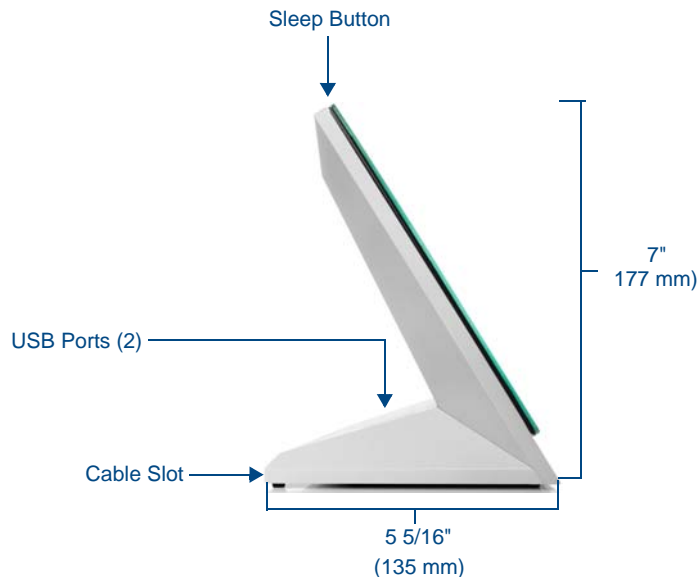

**FIG. 1** MXT-1900L-PAN touch panel

The MXT-1900L-PAN features a 20.4" x 6.9" (519 mm x 175 mm), 20.4" (518 mm) diagonal display, with a viewable area of 18.7" x 5.9" (475 mm x 151 mm), 19.4" (493 mm) diagonal.

The device communicates via Ethernet (10/100 port, RJ-45 connector, supported IP and IP-based protocols: UCP, TCP, ICMP, ICSP, IGMP, DHCP, Telnet, FTP, DNS, RFB for VNC, and HTTP) and USB (3 USB host 2.0, Type A ports and 1 Micro-USB device port).

The MXT-1900L-PAN also supports Near Field Communication (NFC) technology (please see the *NFC* section on page 11 for more information) and Bluetooth keyboard and mouse use via the optional MXA-BT Bluetooth Adapter.



**FIG. 2** MXT-1900L-PAN side view



MXT-1900L-PAN Specifications	
Power Requirements:	12VDC, 4.4A: 2-pin, locking 3.5mm captive wire connector
Power Consumption:	<ul style="list-style-type: none"> <li>• <i>Constant current:</i> 2.7A (32W) @ 12VDC</li> <li>• <i>Start up current:</i> 4.05A (48W) @ 12VDC</li> <li>• <i>Standby current:</i> 0.3A (3.1W) @ 12VDC</li> <li>• <i>Recommended minimum power supply:</i> 4.4A (PSN4.4)</li> </ul>
Front Panel Components:	
NFC Transceiver:	Antenna and transceiver for Near Field Communications device detection and interaction.
Light Sensor:	Photosensitive light detector for automatic adjustment of the panel brightness.
Motion Sensor:	Proximity detector to wake the panel when it is approached. <ul style="list-style-type: none"> <li>• <i>Typical Range:</i> 1 foot (30.48 cm)</li> <li>• <i>Maximum Range:</i> 3 feet (91.44 cm)</li> <li>• <i>Range width:</i> 10 degrees</li> </ul>
LED Indicator:	Camera active indicator.
Sleep Button:	Single button on top of panel for placing panel in sleep mode, for powering off the panel, and for accessing the Settings Pages.
Microphone:	-42dB ± 3dB sensitivity FET microphone.
Speakers:	4 ohm, 2 Watt, 300Hz cutoff frequency.
Camera:	HD 720P camera for video conferencing/video chat support.
Rear Panel Components:	
USB connections:	2 easily accessible USB ports on rear of base, used for connection to keyboard, mouse, or USB flash drive.
Underside Panel Components:	
Ethernet 10/100 Port:	10/100 Base-T RJ-45 connector for Ethernet connectivity. <i>Left green LED:</i> Lights On when the connection speed is 100 Mbps and turns Off when the speed is 10 Mbps. <i>Right yellow LED:</i> Lights On when the Ethernet cables are connected and terminated correctly and then blinks when receiving Ethernet data packets.
Power Port:	Locking 2-Pin, 3.5mm captive wire connector.
Micro-USB Port:	5-pin Micro-USB connector used for camera video and microphone output only.
USB Port:	1 USB port, used for connection to keyboard, mouse, or USB flash drive.
Touch Panel Display:	
Display Type:	TFT Active Matrix Color LCD with In-Plane Switching (IPS) technology.
Size:	19.4" (492.8 mm) diagonal.
Viewing Angle:	<ul style="list-style-type: none"> <li>• <i>Vertical:</i> ± 88°</li> <li>• <i>Horizontal:</i> ± 88°</li> </ul>
Screen Resolution (W x H):	1920x530
Aspect Ratio (W x H):	32x9
Brightness:	350 cd/m2
Contrast Ratio:	1000:1
Color Depth:	16,7M colors.
Backlight Type:	LED
Touch Overlay:	Projected Capacitive; Multi-touch support, 3 simultaneous max.

MXT-1900L-PAN Specifications (Cont.)	
Communications:	
Ethernet:	10/100 port, RJ-45 connector.
USB:	3 - USB host 2.0, Type A ports.
Near Field Communications (NFC):	Supports standards ISO/IEC 15693, ISO/IEC 14443A, ISO/IEC 14443B; Unique Identifier (UID), Typical Range = .25", Max = .5"
Bluetooth:	HID Profile v1.1, Keyboard/Mouse Support, requires MXA-BT Bluetooth Adaptor.
Video:	
Streaming/File Formats:	MPEG-TS for MPEG2; HTTP for MJPEG.
Video Conferencing:	External application using on-board camera and microphone through Micro-USB connection.
Audio:	
Streaming/File Formats:	WAV, MP3.
Intercom:	Full Duplex VoIP, SIP v2.0 (supported with AMX-CSG).
Operating Environment:	<ul style="list-style-type: none"> <li>• Operating Temperature: 32° F to 104° F (0° C to 40° C)</li> <li>• Storage Temperature: 4° F to 140° F (-20° C to 60° C)</li> <li>• Humidity Operating: 20% to 85% RH</li> <li>• Humidity Storage: 5% to 85% RH</li> </ul>
Dimensions (HWD):	7" x 20 7/16" x 5 5/16" (177.8 mm x 519 mm x 134.6 mm)
Weight:	9.4 lbs (4.26 Kg)
Certifications:	<ul style="list-style-type: none"> <li>• FCC Part 15 Class B</li> <li>• C-Tick CISPR 22 Class B</li> <li>• CE EN 55022 Class B and EN 55024</li> <li>• CB Scheme IEC 60950-1</li> </ul>
Included Accessories:	<ul style="list-style-type: none"> <li>• MXT-1900L-PAN Installation Guide (<b>93-5968-02</b>)</li> <li>• MXA-CLK Modero X Series Cleaning Kit (<b>FG5968-16</b>)</li> <li>• 3.5mm Locking Captive Wire Connector (<b>41-0002-SA</b>)</li> <li>• HPG-10 .75-inch HydraPort .75-IN. Grommet (<b>FG570-01</b>)</li> <li>• Type A USB Covers (2)</li> <li>• Tie Wrap for Power Source Ferrite</li> </ul>
Other AMX Equipment:	<ul style="list-style-type: none"> <li>• PSN4.4 4.4AMP, 13.5VDCA5 Power Supply (<b>FG423-45</b>)</li> <li>• MXA-USB-C USB Cover Kit (<b>FG5968-18</b>)</li> <li>• MXA-BT Bluetooth USB Adaptor (<b>FG5968-19</b>)</li> </ul>

### Connector Locations

With the unit facing you, the two USB ports for peripherals are located on the rear right corner of the device (FIG. 3). The power and Ethernet connectors, as well as an additional USB port and a 5-pin Micro-USB port, are located on the bottom of the device.



**FIG. 3** MXT-1900L-PAN USB port location

In addition to its speaker, the MXT-1900L-PAN also utilizes its Micro-USB port for video output from camera video and microphone output.

### Memory

The MXT-1900L-PAN comes with 512 MB of SDRAM and 4 GB of Flash memory, neither of which can be upgraded. A maximum of 2.4 GB is available to the user for projects.

### Basic Operation

The MXT-1900L-PAN is operated using its integral touchscreen, as well as the Sleep button on the top of the device (FIG. 1). If the device has gone into its Sleep Mode, a touch of the touchscreen or of the Sleep button will reactivate it.

### Powering on the MXT-1900L-PAN

The MXT-1900L-PAN may be powered on by touching and holding the **Sleep** button on the top of the device.

### Microphone

The MXT-1900L-PAN contains a built-in microphone above the touch screen for video and audio conferencing capabilities. This microphone is concealed by the casing.

### Audio/Video Capabilities

The MXT-1900L-PAN has the capability of displaying multiple JPEG and PNG files at one time. The device also supports streaming motion JPEG video (of the sort used by many IP and Web cameras), as well as MP3 and WAV audio files.

### MXT-1900L-PAN-NC

The MXT-1900L-PAN-NC (**FG5968-21**) No Comm touch panel does not have camera, microphone, or NFC capability. It otherwise has all of the functionality of the MXT-1900L-PAN panel.

## MXD-1900L-PAN

The MXD-1900L-PAN 19.4" Modero X Series Panoramic Wall Touch Panels (*Portrait Wall Mount: FG5968-06; Landscape Wall Mount: FG5968-12*) are ideal for boardrooms, conference rooms, or auditoriums where a panoramic control surface is needed to provide access to multiple functions simultaneously while remaining elegantly unobtrusive. In residences, they are perfect for kitchens, home theaters, or home offices where the panoramic control surface can be used to manage systems throughout the house.

The MXD-1900L-PAN features a 20.4" x 6.9" (519 mm x 175 mm), 20.4" (518 mm) diagonal display, with a viewable area of 18.7" x 5.9" (475 mm x 151 mm), 19.4" (493 mm) diagonal.

The device communicates via Ethernet (10/100 port, RJ-45 connector, supported IP and IP-based protocols: UCP, TCP, ICMP, ICSP, IGMP, DHCP, Telnet, FTP, DNS, RFB for VNC, and HTTP) and USB (2 USB host 2.0, Type A ports and 1 Micro-USB device port).

The MXD-1900L-PAN also supports Near Field Communication (NFC) technology (please see the *NFC* section on page 11 for more information) and Bluetooth keyboard and mouse use via the optional MXA-BT Bluetooth Adapter.



FIG. 4 MXD-1900L-PAN, Landscape Wall Mount



FIG. 5 MXD-1900L-PAN, Portrait Wall Mount

MXD-1900L-PAN Specifications	
Power Requirements:	12VDC, 4.4A: 2-pin, locking 3.5mm captive wire connector
Power Consumption:	<ul style="list-style-type: none"> <li>• <i>Constant current:</i> 2.7A (32W) @ 12VDC</li> <li>• <i>Start up current:</i> 4.05A (48W) @ 12VDC</li> <li>• <i>Standby current:</i> 0.3A (3.1W) @ 12VDC</li> <li>• <i>Recommended minimum power supply:</i> 4.4A (PSN4.4)</li> </ul>
Front Panel Components:	
NFC Transceiver:	Antenna and transceiver for Near Field Communications device detection and interaction.
Light Sensor:	Photosensitive light detector for automatic adjustment of the panel brightness.
Motion Sensor:	Proximity detector to wake the panel when it is approached. <ul style="list-style-type: none"> <li>• <i>Typical Range:</i> 1 foot (30.48 cm)</li> <li>• <i>Maximum Range:</i> 3 feet (91.44 cm)</li> <li>• <i>Range width:</i> 10 degrees</li> </ul>
LED Indicator:	Camera active indicator (landscape only)
Sleep Button:	Single button on edge of panel for placing panel in sleep mode, for powering off panel, and for access to Settings pages.
Microphone:	-42dB +/- 3dB sensitivity FET microphone
Speakers:	4 ohm, 2 Watt, 300Hz cutoff frequency
Camera (landscape only):	HD 720P camera for video conferencing/video chat support.
Rear Panel Components:	
Ethernet 10/100 Port:	10/100 Base-T RJ-45 connector for Ethernet connectivity.
Power Port:	Locking 2-Pin, 3.5mm captive wire connector.
Micro-USB Port:	5-pin Micro-USB connector used for video output from camera video (Landscape Only) and microphone output only.
USB Ports (2):	USB connectors used for keyboard and mouse connections, or for firmware uploads. Side port may require right angle mating connector (not included) for some configurations.
Touch Panel Display:	
Display Type:	TFT Active Matrix Color LCD with In-Plane Switching (IPS) technology.
Display Size (W x H):	<ul style="list-style-type: none"> <li>• <i>Landscape:</i> 20.4" x 6.9" (519 mm x 175 mm)</li> <li>• <i>Portrait:</i> 6.9" x 20.4" (175 mm x 519 mm)</li> <li>• 20.4" (518 mm) diagonal</li> </ul>
Viewable Area (W x H):	<ul style="list-style-type: none"> <li>• <i>Landscape:</i> 18.7" x 5.9" (475 mm x 151 mm)</li> <li>• <i>Portrait:</i> 5.9" x 18.7" (151 mm x 475 mm)</li> <li>• 19.4" (493 mm) diagonal</li> </ul>
Viewing Angle:	<ul style="list-style-type: none"> <li>• <i>Vertical:</i> ± 89°</li> <li>• <i>Horizontal:</i> ± 89°</li> </ul>
Screen Resolution (W x H):	<ul style="list-style-type: none"> <li>• <i>Landscape:</i> 1920x530</li> <li>• <i>Portrait:</i> 530x1920</li> </ul>
Aspect Ratio (W x H):	<ul style="list-style-type: none"> <li>• <i>Landscape:</i> 18:5</li> <li>• <i>Portrait:</i> 5:18</li> </ul>
Brightness:	350 cd/m2
Contrast Ratio:	1000:1
Color Depth:	16,7M colors
Backlight Type:	LED
Touch Overlay:	Projected Capacitive; Multi-touch support, 3 simultaneous max.

MXD-1900L-PAN Specifications (Cont.)	
Communications:	
Ethernet:	10/100 port, RJ-45 connector
USB:	2 - USB host 2.0, Type A ports
Near Field Communications (NFC):	Supports standards ISO/IEC 15693, ISO/IEC 14443A, ISO/IEC 14443B; Unique Identifier (UID), Typical Range = .25", Max = .5"
Bluetooth:	HID Profile v1.1, Keyboard/Mouse Support, requires MXA-BT Bluetooth Adaptor
Video:	
Streaming/File Formats:	MPEG-TS for MPEG2; HTTP for MJPEG
Video Conferencing:	External application using on-board camera and microphone through Micro-USB connection.
Audio:	
Streaming/File Formats:	WAV, MP3
Intercom:	Full Duplex VoIP, SIP v2.0 (supported with AMX-CSG)
Operating Environment:	<ul style="list-style-type: none"> <li>• Operating Temperature: 32° F to 104° F (0° C to 40° C)</li> <li>• Storage Temperature: 4° F to 140° F (-20° C to 60° C)</li> <li>• Humidity Operating: 20% to 85% RH</li> <li>• Humidity Storage: 5% to 85% RH</li> </ul>
Dimensions (HWD):	<ul style="list-style-type: none"> <li>• <i>Landscape</i>: 6.9" x 20.4" x 0.7" (175 mm x 519 mm x 19 mm)</li> <li>• <i>Portrait</i>: 20.4" x 6.9" x 0.7" (519 mm x 175 mm x 19 mm)</li> </ul>
Weight:	7.0 lbs (3.18 Kg)
Certifications:	<ul style="list-style-type: none"> <li>• FCC Part 15 Class B</li> <li>• C-Tick CISPR 22 Class B</li> <li>• CE EN 55022 Class B and EN 55024</li> <li>• CB Scheme IEC 60950-1</li> </ul>
Included Accessories:	<ul style="list-style-type: none"> <li>• MXD-1900L-PAN Installation Template (<b>68-5968-02</b>)</li> <li>• MXA-CLK Modero X Series Cleaning Kit (<b>FG5968-16</b>)</li> <li>• 3.5mm Locking Captive Wire Connector (<b>41-0002-SA</b>)</li> </ul>
Other AMX Equipment	<ul style="list-style-type: none"> <li>• PSN4.4 4.4AMP, 13.5VDC A5 Power Supply (<b>FG423-45</b>)</li> <li>• MXA-BT Bluetooth USB Adaptor (<b>FG5968-19</b>)</li> <li>• MXA-USB-C USB Cover Kit (<b>FG5968-18</b>)</li> <li>• CB-MXP Panoramic Rough-In Box (<b>FG039-15</b>)</li> </ul>

## Memory

The MXD-1900L-PAN comes with 512 MB of SDRAM and 4 GB of Flash memory, neither of which can be upgraded. A maximum of 2.4 GB is available to the user for projects.

## Basic Operation

The MXD-1900L-PAN is operated using its integral touchscreen, as well as the **Sleep** button on the top of the device (FIG. 1). If the device has gone into its Sleep Mode, a touch of the touchscreen or of the **Sleep** button will reactivate it.

## Powering on the MXD-1900L-PAN

The MXD-1900L-PAN may be powered on by touching and holding the **Sleep** button on the top of the device.

## Microphone

The MXD-1900L-PAN contains a built-in microphone above the touch screen for video and audio conferencing capabilities. This microphone is concealed by the casing.

## Audio/Video Capabilities

The MXD-1900L-PAN has the capability of displaying multiple JPEG and PNG files at one time. The device also supports streaming motion JPEG video (of the sort used by many IP and Web cameras), as well as MP3 and WAV audio files.

## MXD-1900L-PAN-NC

The MXD-1900L-PAN-P-NC (FG5968-22) and MXD-1900L-PAN-L-NC (FG5968-23) No Comm touch panels do not have camera, microphone, or NFC capability. These otherwise have all of the functionality of the MXD-1900L-PAN panels.

## MXD/T-1900L-PAN Features

### Picture View

By connecting a USB drive via one of the device's USB ports (FIG. 3), Picture View allows the MXT-1900L-PAN to access JPEG images on that drive and display them on the touchscreen (FIG. 6). Individual images may be accessed at any time, or the entire collection may be displayed for predetermined times. Picture View may be stopped at any time by removing the USB drive, and the MXT-1900L-PAN will return to its default display page.



FIG. 6 Picture View display



NOTE

*Picture View may also be used on the MXD-1900L-PAN, but its use requires some form of access to the USB ports on the rear of the device.*



NOTE

*The maximum source resolution for Picture View is 1920x1920 pixels. The maximum displayed resolution is the same as the screen resolution.*

To start Picture View:

1. Ensure that the device has been enabled for Picture View through the ^PIC Send Command.
2. Connect a USB drive to the device. Picture View will automatically recognize all available images on the drive and start displaying them on the touchscreen.
3. When the images begin to display, touch any place on the touchscreen to open the configuration popup menu (FIG. 7). If no selection is made, this menu will remain in place for 15 seconds and then disappear. It may be accessed again by touching anywhere on the touchscreen.

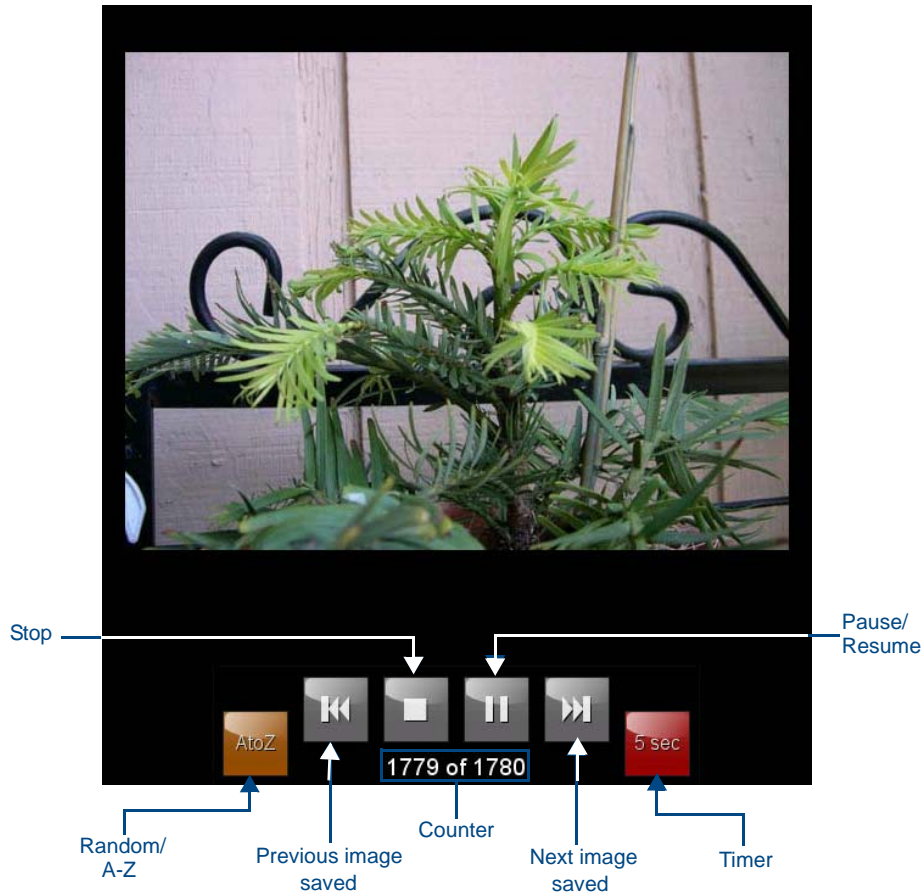

**FIG. 7** Picture View configuration popup menu

4. On the leftmost amber button, select between **Rand** (images display at random) and **A-Z** (images display in alphabetical order based on the name of the file).
5. The four grey buttons allow scrolling through saved images and the rate of display:
  - The **Previous Image Saved** button returns the display to the first image uploaded by Page View.
  - The **Stop** button stops Page View and returns to the default panel page.
  - The **Pause/Resume** button allows the display to stop on one particular image. Press it again to resume the display procession.
  - The **Next Image Saved** button returns the display to the last image uploaded by Page View. If the panel has not accessed all of the images available on a USB drive, Page View will display the last one uploaded to date.
6. On the rightmost red button, select the number of seconds a selected image will be displayed in Picture View. This may be selected between 5, 10, 15, 30, and 60 seconds.
7. The counter beneath the buttons displays the number of images currently uploaded by the MXT-1900L-PAN versus the number detected on the USB drive.

### Preview Mode and Normal Mode

Picture View has two modes: Preview Mode and Normal Mode. Preview Mode allows the user to configure Picture View. Once a USB drive containing images is inserted into the panel, the images will begin to display. Touching any place on the display will result in the configuration popup to slide from the bottom of the display.

Picture View goes into its Normal Mode when the MXT-1900L-PAN goes into idle timeout while connected to a USB drive. Normal Mode displays images until the touchscreen is touched, or some other wakeup event is detected. When the device goes back into timeout, Normal Mode will return to displaying images until the USB drive is removed from the device.



### Picture View Send Command

The ^PIC Send Command stops either mode of Picture View, or starts Preview Mode. For more information, please refer to the *Modero X Programming Guide*, available at [www.amx.com](http://www.amx.com).



NOTE

All images must be in JPEG format. PNG and other image formats cannot be viewed through Picture View.

### Configuration

The MXT-1900L-PAN and MXD-1900L-PAN are equipped with Settings Pages that allow you to set and configure various features on the panels. For more information on connecting and configuring the touch panels to a network, please refer to the *Modero X Series Programming Guide*, available at [www.amx.com](http://www.amx.com).

### Bluetooth Support

Both the MXT-1900L-PAN and the MXD-1900L-PAN allow the use of Bluetooth keyboard and mouse combinations, using HID Profile v1.1. Using a keyboard and mouse with the device requires use of the MXA-BT Bluetooth USB Adaptor (FG5968-19).

### NFC

Both the MXT-1900L-PAN and the MXD-1900L-PAN support Near Field Communications™ (NFC) Technology. NFC technology facilitates making transactions, exchanging digital content, and connecting electronic devices with a touch. NFC transmissions are short-range (from a touch to a few centimeters), working with existing contactless card technologies and containing built-in capabilities to support secure applications. By using NFC technology, users may receive access to touch panels and touch panel pages through access badges and other card options.

Common Access Card (CAC) Support In MXT/D-1900L-PAN			
Card Type	Card Unique Identifier (UID)	Card Data	Personal Identity Verification (PIV) Card holder UID
15693	8 byte UID	Not Supported	N/A
14443A Non-Gov't	4, 7 or 10 byte UID (1)	Not Supported	N/A
14443A Gov't	4, 7 or 10 byte UID (1)	Not Supported (2)	Not currently
14443B Non-Gov't	4 byte UID	Not Supported	N/A
14443B Gov't	4 byte UID	Not Supported (2)	Not currently
FeliCa	Not Supported	Not Supported	N/A
(1) The UID can be a fixed unique number or a random number dynamically generated by the card.			
(2) Requires contact card reader (not accessible via NFC)			

The maximum range for the NFC antenna is 0.5" (12.7 mm), but the typical usage range is 0.25" (6.35 mm). The antenna itself is accessible from the front of the panel, 3.25" (82.55 mm) from the left corner of the panel and 0.375" (9.53 mm) from the top edge. When using an NFC device with the MXT-1900L-PAN, you should align your device's antenna with the center of the touch panel's antenna (FIG. 8).

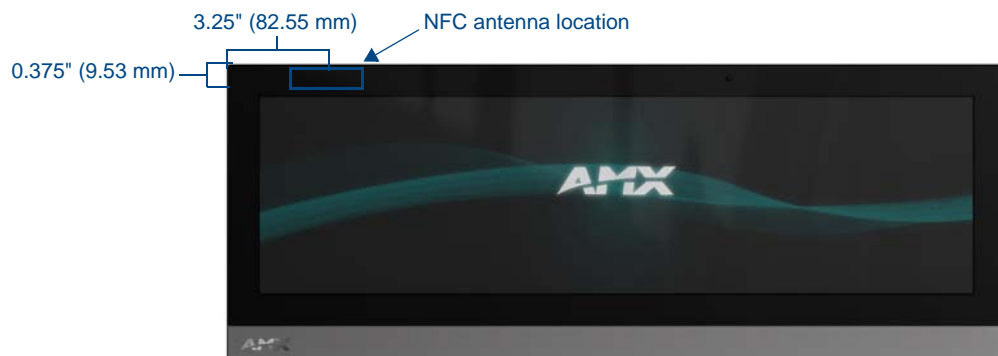

FIG. 8 NFC antenna location on the MXT-1900L-PAN



*To facilitate NFC antenna access, you may want to add an icon to the panel's page(s), pointing to the location of the antenna on the panel.*

### **Cleaning the Touch Overlay and Case**

Both the MXT-1900L-PAN and the MXD-1900L-PAN come with the MXA-CLK Modero X Series Cleaning Kit (**FG5968-16**), which may be used to clean fingerprints and dirt from the device. This kit comes with cleaning cloths and a bottle of cleaning fluid specifically for use with the device.

When cleaning the device, **do not directly spray the device with cleaning fluid**. Instead, spray the cloth and then apply the cloth to the touch screen. Do **NOT** use abrasives of any type to clean the device, as abrasives may permanently damage or remove the device's finish.

# Installation

## MXT-1900L-PAN Installation

Other than the two USB ports on the back of the device (FIG. 3), the power and data connectors for the MXT-1900-PAN are located on the underside of the device (FIG. 9). The Micro-USB port is used for camera video output. The underside USB port, as well as the two rear USB ports, may be used with a flash drive for page transfers, firmware upgrades, or Picture View. Any USB peripherals (mouse, keyboard, etc.) may be connected to one of the two USB ports on the rear of the device.

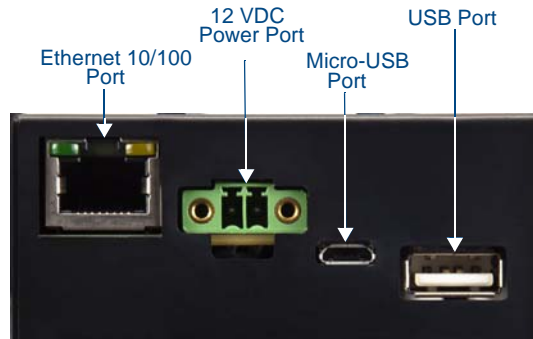

**FIG. 9** MXT-1900L-PAN underside connectors

The MXT-1900L-PAN does not have individual channels on the base of the device to allow passage of cables from underneath the base. Instead, it has one slot at the base to allow options on cable configuration, with channels for securing power, Ethernet, and Micro-USB cables (FIG. 10).

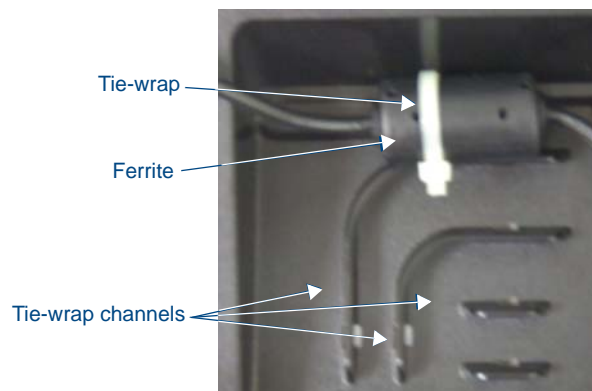

**FIG. 10** Tie-wrap for power connector ferrite

Each channel side has slots for attaching tie-wraps to secure each cable. The ferrite on the power cable must be secured with the included tie-wrap during installation to prevent the possibility of the panel not sitting flush on the table. Other cables may be secured with tie-wraps if desired, but this is not necessary.

## Wiring Guidelines

The MXT-1900L-PAN uses a 12 VDC-compliant power supply to provide power to the panel via the 2-pin 3.5 mm captive wire PWR connector. Use the previously provided power requirement information in the *Specifications* table on page 3 to determine the power draw. The incoming PWR and GND wires from the power supply must be connected to the corresponding locations within the PWR connector.



NOTE

*Apply power to the panel only after installation is complete.*



Connecting power to the MXT-1900L-PAN should be done using the included 2-pin 3.5mm captive wire connector included with the device. This connector is retained within its port with locking screws instead of the pins on each side of standard captive wire connectors, and using force to insert a standard captive wire connector may damage the device.

### Wiring a Power Connection

To use the 2-pin 3.5 mm captive wire connector with a 12 VDC-compliant power supply, the incoming PWR and GND wires from the external source must be connected to their corresponding locations on the connector (FIG. 11). The connector uses locking screws to insure a connection to the device, so make sure to insert and tighten the screws before applying power.

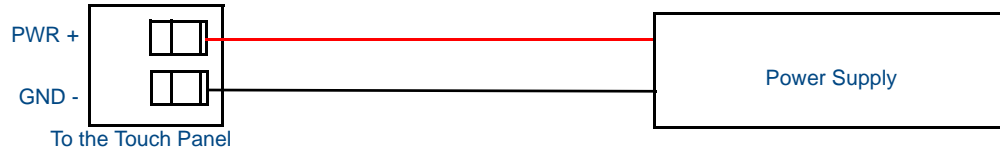

**FIG. 11** NetLinx power connector wiring diagram

1. Insert the PWR and GND wires on the terminal end of the 2-pin 3.5 mm captive wire cable. *Match the wiring locations of the +/- on both the power supply and the terminal connector.*
2. Tighten the clamp to secure the two wires. *Do not tighten the screws excessively; doing so may strip the threads and damage the connector.*
3. Verify the connection of the 2-pin 3.5 mm captive wire to the external 12 VDC-compliant power supply and apply power.

## A Note About Wall and Rack Installation

Some products are installed in areas of differing temperature and cooling methodologies. These include products installed in walls, racks, cabinets, etc. Those areas may have different temperatures and/or cooling approaches that must be taken into consideration to maintain the product within the specified operating temperature.

FIG. 12 shows an AMX device installed in a wall with a filled volume (such as with insulation or concrete), as well as with a closed volume (such as between studs in an otherwise finished wall). The diagram shows how heat generated by the device or other devices may have no way to escape, and may build up to levels that may affect device operation.

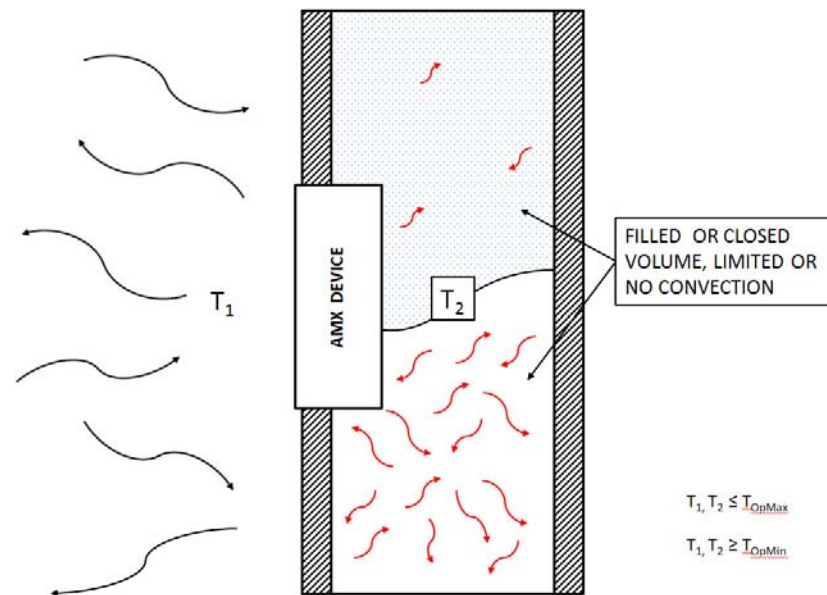

**FIG. 12** Heat convection in filled or closed volume, limited or no convection

In FIG. 13, the diagram displays an AMX device in a typical rack mounting, with full air circulation around the front and back of the device. In this case, the main concern is with heat building up between components, possibly to levels that may affect device operation.

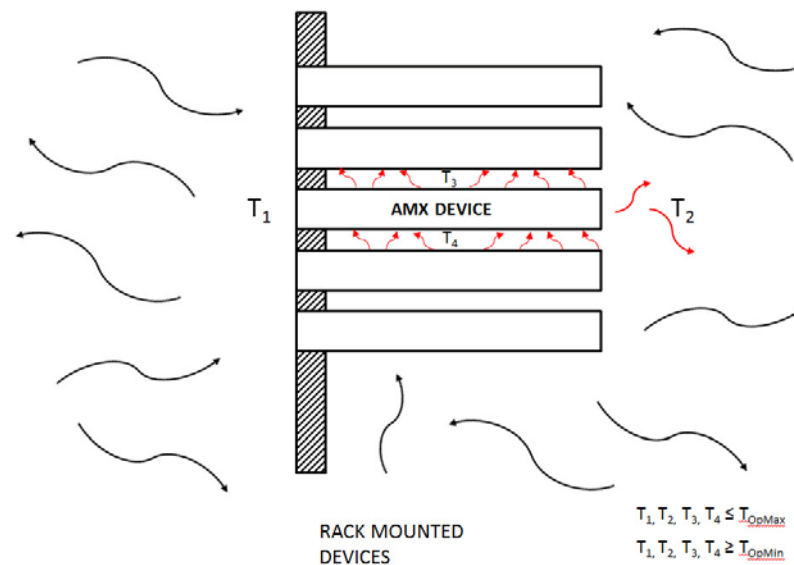

**FIG. 13** Heat convection in rack-mounted devices

### Installation Recommendations

During any installation, a lack of ventilation may produce conditions that may adversely affect the device's operation. In these circumstances, special care must be made to make sure that temperatures within enclosed areas do not exceed the device's maximum rated temperature.



*While the outside temperature of the device may be at or below its maximum operating temperature, special care must be taken before and during installation to ensure that the maximum operating temperature is not exceeded within wall or rack installation spaces.*

### MXD-1900L-PAN Installation

The MXD-1900L-PAN may be installed directly into a solid surface environment, using either solid surface screws or the included locking tabs for different mounting options. Once installed, the MXD-1900L-PAN is contained within a clear outer housing known as the back box. This back box is removed when installing the device into a wall or into a Rough-In Box.

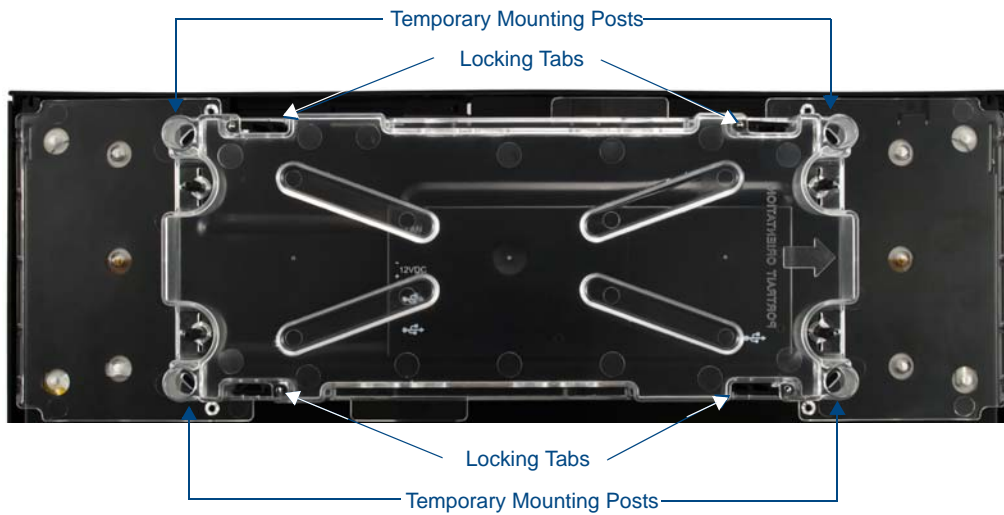

**FIG. 14** MXD-1900L-PAN Back Box

#### Installing the MXD-1900L-PAN into a wall

The MXD-1900L-PAN comes with a clear plastic backbox (FIG. 14) designed to attach the panel to most standard wall materials. This backbox has four locking tabs (two on top and two on bottom) to help lock the backbox to the wall. These locking tabs are only extended AFTER the backbox is inserted into the wall. The backbox also has four slots for accepting the temporary mounting posts mounted on the back of the device (FIG. 15 and FIG. 16).



*When installing the backbox, make sure that the assembly is in the correct position and in the correct place. Once the locking tabs are extended and locked into place, removing the backbox may be difficult without having access to the back of the wall or causing damage to the wall.*

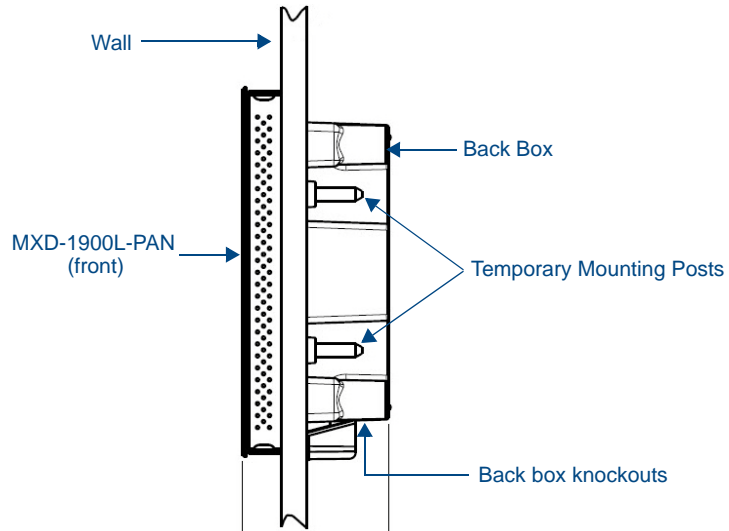

**FIG. 15** Side view of installed MXD-1900L-PAN (Landscape)

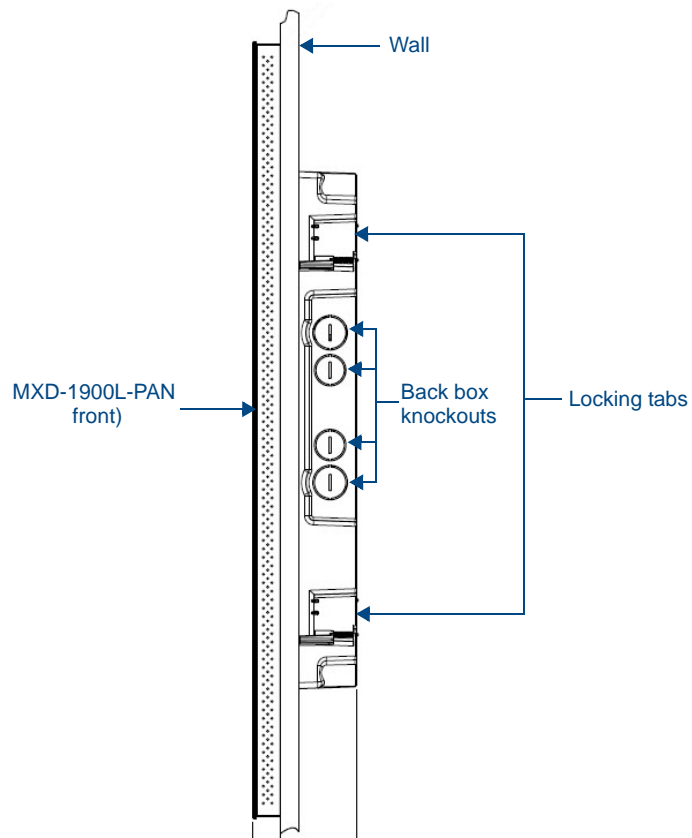

**FIG. 16** Side view of installed MXD-1900L-PAN (Portrait)



*In order to guarantee a stable installation of the MXD-1900L-PAN, the thickness of the wall material must be a minimum of .50 inches (1.27cm) and a maximum of .875 inches (2.22cm).*



The maximum recommended torque to screw in the locking tabs on the plastic back box is 5 IN-LB [56 N-CM]. Applying excessive torque while tightening the tab screws, such as with powered screwdrivers, can strip out the locking tabs or damage the plastic back box.

To install the back box:

1. Prepare the area by removing any screws or nails from the drywall before beginning the cutout process.
2. Since the cutout for the back box is off-center from the edges of the touch panel, use the MXD-1900L-PAN Installation Template (**68-5968-02**) to ensure proper placement (FIG. 17).

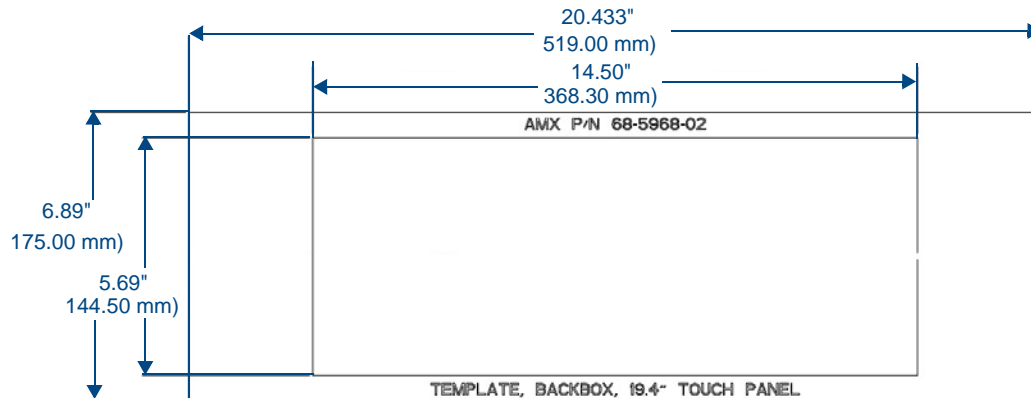

**FIG. 17** MXD-1900L-PAN Template



Using the included template to select the final placement of the back box is highly recommended. The outside edges of the template are the same dimensions as the touch panel, which allows you to troubleshoot possible conflicts with wall edges, doors, and other potential obstacles.

3. Cut out the surface for the back box.



Making sure that the actual cutout opening is slightly smaller than the provided dimensions is highly recommended. This action provides the installer with a margin for error if the opening needs to be expanded. Too little wall material removed is always better than too much.

4. Thread the incoming power, Ethernet, and Micro-USB wiring (if Micro-USB access is desired) from their terminal locations through the surface opening (FIG. 18 and FIG. 19). Leave enough slack in the wiring to accommodate any re-positioning of the panel.
5. Remove any knockouts as needed on either long dimension of the back box (FIG. 18 and FIG. 19) to facilitate incoming wiring and pull the wiring through the resultant holes.
6. Push the back box into the wall opening. Insure that the locking tabs lie flush against the back box.



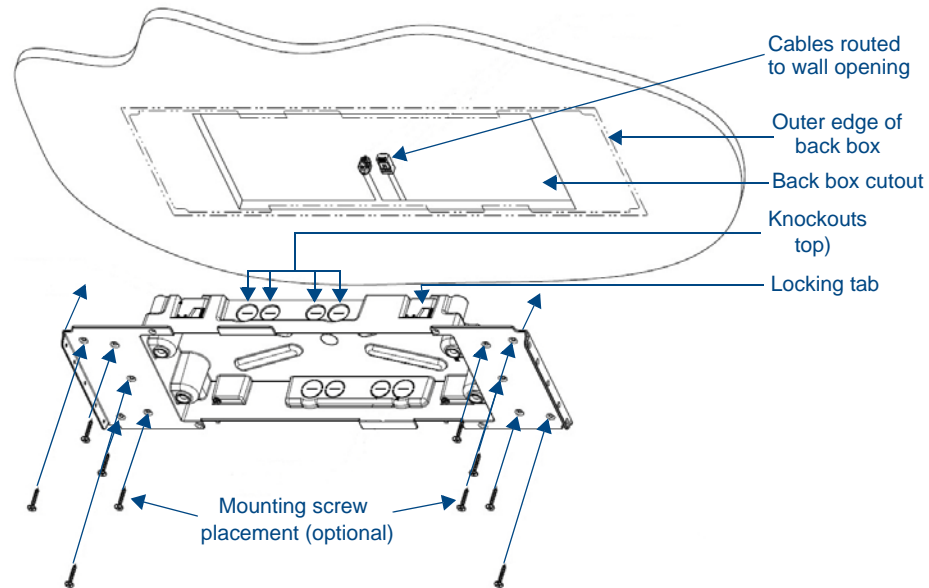

**FIG. 18** MXD-1900L-PAN Back Box installation (Landscape)

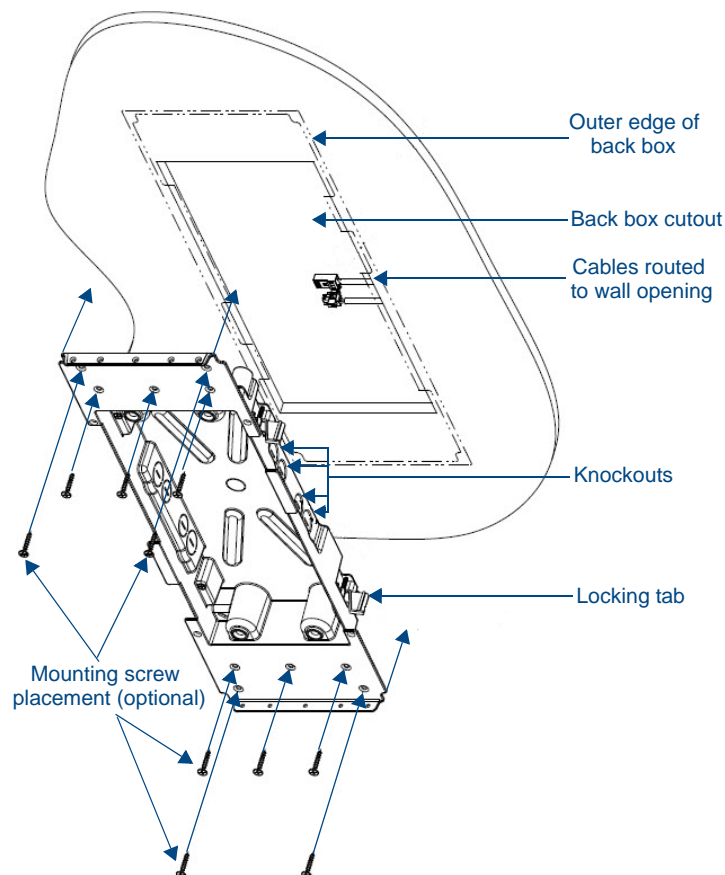
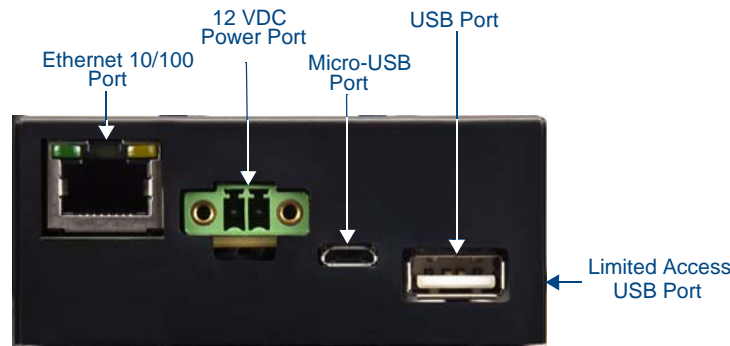

**FIG. 19** MXD-1900L-PAN Back Box installation (Portrait)

7. Extend the locking tabs on the sides of the back box by tightening the screws inside the box until snug. Not all of the tabs must be extended to lock the back box in place, but extending a minimum of the top and bottom tabs is highly recommended. Apply enough pressure to the screw head to keep the box flush with the wall: this ensures that the locking tabs will tighten up against the inside of the wall.

The back box is clear to allow visual confirmation that the tabs have been extended and are gripping the wall, as well as in assisting with removal if necessary.

8. For additional strength, #4 mounting screws (not included) may be secured through circular holes located at the left and right sides of the MXD-1900L-PAN (FIG. 18 and FIG. 19). In order to prevent damage to the touch panel, make sure that these are flush with the back box.
9. Insert each connector into its corresponding location along the back of the device (FIG. 20).



**FIG. 20** MXD-1900L-PAN rear connectors (front view)

10. Test the incoming wiring by attaching the panel connections to their terminal locations and applying power. Verify that the panel is receiving power and functioning properly to prevent repetition of the installation.



NOTE

*Do not disconnect the connectors from the touch panel. The unit must be installed with the attached connectors before being inserted into the drywall.*



NOTE

*Configurations that use the limited access USB port on the side of the connector box may require a right angle mating connector (not included) for connection to the device.*

Insert the four temporary mounting posts of the panel (FIG. 21 and FIG. 22) into the openings on the back box and slide the panel onto the back box. This will temporarily hold the panel during the rest of the installation.

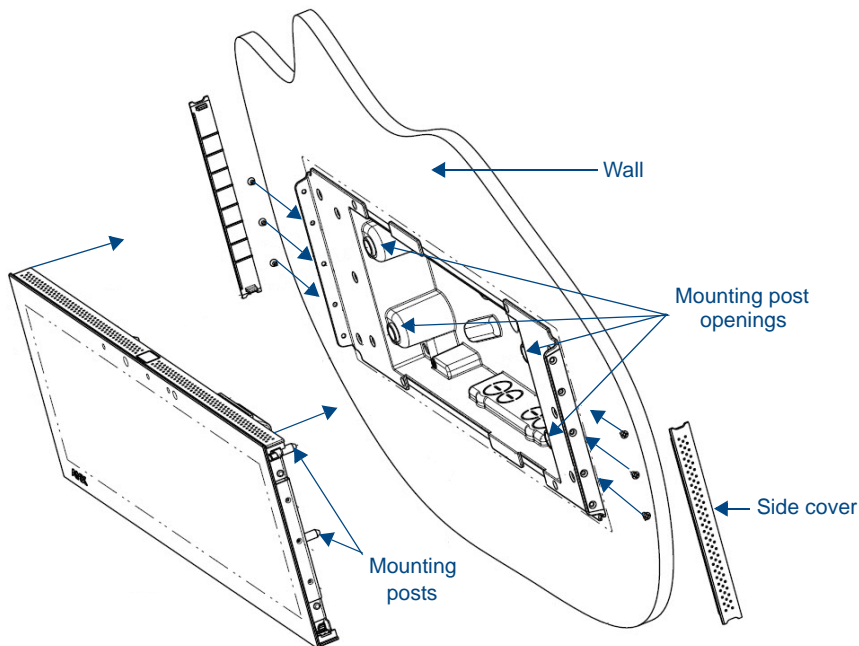

**FIG. 21** MXD-1900L-PAN installation (Landscape)

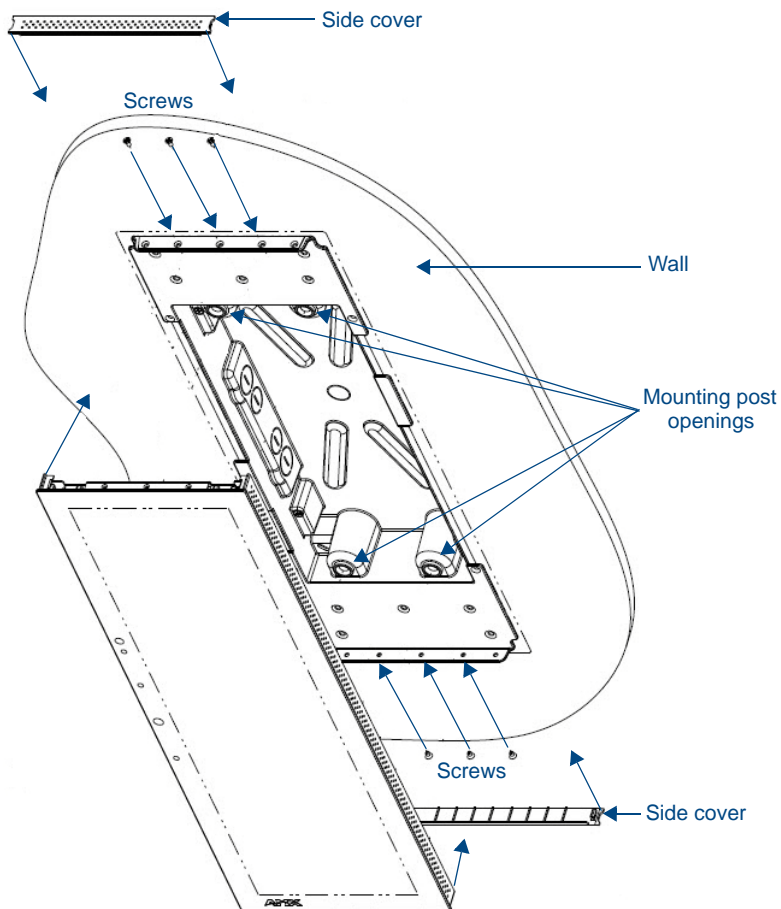
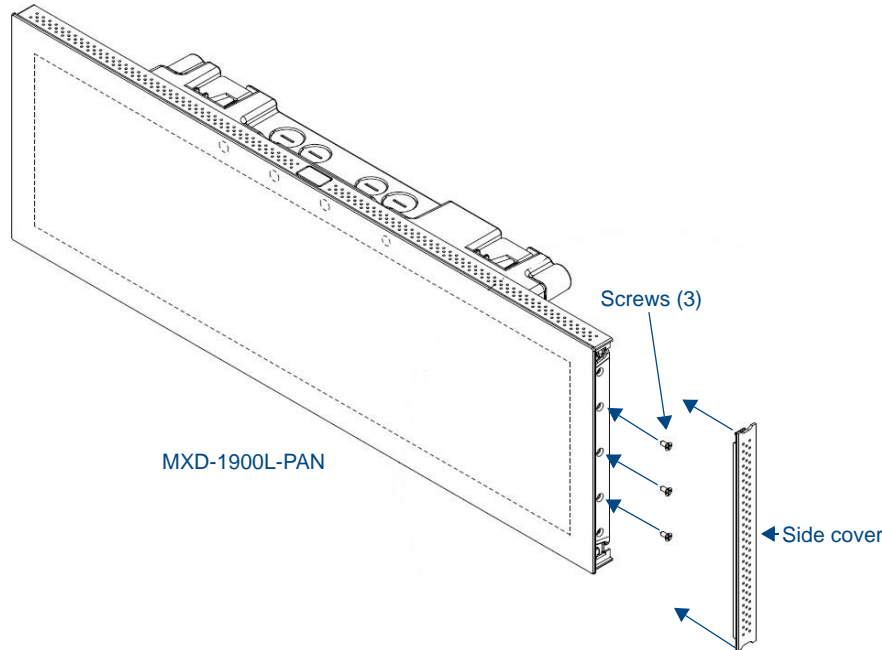

**FIG. 22** MXD-1900L-PAN installation (Portrait)



When installing the panel, **do NOT press on or near the center of the panel**. Too much stress at the center may damage the touch screen surface. When installing the panel, pressure should be applied toward the ends of the panel **ONLY**.

- Use the six provided screws, three at each end, to secure the touch panel to the back box (FIG. 22 and FIG. 23). Use only the provided screws, as other screws may damage the touch panel.

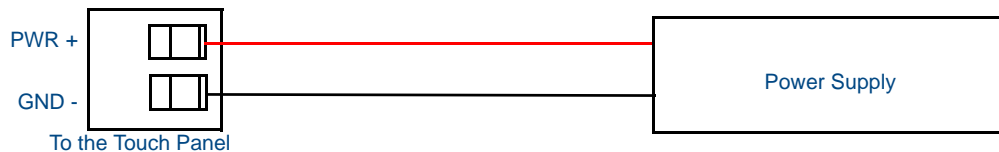

**FIG. 23** MXD-1900L-PAN side cover installation (Landscape)

- Snap the decorative side covers (FIG. 23) onto each end of the touch panel.
- Reconnect the terminal Ethernet and USB to their respective locations on either the Ethernet port or NetLinx Master.

### Wiring a Power Connection

To use the 2-pin 3.5 mm captive wire connector with a 12 VDC-compliant power supply, the incoming PWR and GND wires from the external source must be connected to their corresponding locations on the connector (FIG. 24). The connector uses locking screws to insure a connection to the device, so make sure to insert and tighten the screws before applying power.



**FIG. 24** NetLinx power connector wiring diagram

- Insert the PWR and GND wires on the terminal end of the 2-pin 3.5 mm captive wire cable. *Match the wiring locations of the +/- on both the power supply and the terminal connector.*
- Tighten the clamp to secure the two wires. *Do not tighten the screws excessively; doing so may strip the threads and damage the connector.*
- Verify the connection of the 2-pin 3.5 mm captive wire to the external 12 VDC-compliant power supply and apply power.

# Configuration and Programming



*Programming the MXT-1900L-PAN and MXD-1900L-PAN require the use of the latest versions of NetLinx Studio and TPDesign 4, both available at [www.amx.com](http://www.amx.com).*

## Modero X Series Programming Guide

Information on *Settings* pages, panel configuration, and programming is included in the *Modero X Series Programming Guide*, available at [www.amx.com](http://www.amx.com).



# Upgrading Firmware

## Overview

The latest firmware (\*.kit) file for each panel is available to download from [www.amx.com](http://www.amx.com). To download firmware files, go to the catalog page for your panel type, and click the link under "**Firmware Files**" on the right side of the catalog page (FIG. 25):



**FIG. 25** [www.amx.com](http://www.amx.com) - example "Firmware Files" link on a touch panel catalog page

The ZIP file that is downloaded via this link contains the firmware (\*.kit) file that can be loaded on the panel (as well as release notes and any relevant programming instructions).

## Upgrading Firmware via USB Flash Drive

Firmware and TPDesign4 files may be transferred to the panel via USB flash drive. When looking at the device from the front, the MXD-1900L-PAN has two USB ports on the rear right of the device (FIG. 3).

### Load the Firmware on a USB Flash Drive

1. Insert the USB flash drive in an available USB port on your PC.
  - The flash drive must be in either FAT32 or FAT16 format.
  - 32GB is the maximum acceptable size for flash drives used with touch panels
  - For wall-mounted panels (MXD-xxx), accessing the USB ports may require removing the panel from the wall mount (if a USB extension was not already installed).
2. Create a directory on the USB flash drive with one of the following names, depending on the panel you are upgrading:
  - Note that the name must match exactly (do not include the quotes)
  - These directory names are *not* case-sensitive:

Directory Names for Firmware Files - by Touch Panel Type		
Directory Name	Panel Type(s)	
"MXD-2000XL-PAN"	MXD-2000XL-PAN-P (FG5968-05) MXD-2000XL-PAN-L (FG5968-11)	MXD-2000XL-PAN-P-NC (FG5968-33) MXD-2000XL-PAN-L-NC (FG5968-34)
"MXT-2000XL-PAN"	MXT-2000XL-PAN (FG5968-01)	MXT-2000XL-PAN-NC (FG5968-32)
"MXD-1900L-PAN"	MXD-1900L-PAN-P (FG5968-06) MXD-1900L-PAN-L (FG5968-12)	MXD-1900L-PAN-P-NC (FG5968-22) MXD-1900L-PAN-L-NC (FG5968-23)
"MXT-1900L-PAN"	MXT-1900L-PAN (FG5968-02)	MXT-1900L-PAN-NC (FG5968-21)
"MXT-1000"	MXT-1000 (FG5968-03)	MXT-1000-NC (FG5968-24)
"MXD-1000"	MXD-1000-P (FG5968-07) MXD-1000-L (FG5968-13)	MXD-1000-P-NC (FG5968-25) MXD-1000-L-NC (FG5968-26)
"MXT-700"	MXT-700 (FG5968-04)	MXT-700-NC (FG5968-27)
"MXD-700"	MXD-700-P (FG5968-08) MXD-700-L (FG5968-14)	MXD-700-P-NC (FG5968-28) MXD-700-L-NC (FG5968-29)
"MXD-430"	MXD-430-P (FG5968-15)	

3. Copy the firmware (.kit) file to be transferred (for example, "SW5968\_ModeroX\_v2\_103\_52.kit") into this directory on the flash drive.



Make sure this is the only .kit file in this directory - if not, the latest version will be used.

NOTE

4. Eject or unmount the flash drive from the PC.

### Transfer the Firmware File From the Flash Drive to the Touch Panel

1. Connect the USB Flash Drive to one of the USB Type A ports on the panel.



The Micro USB port cannot be used for firmware upgrades.

NOTE

2. Go to the **Install Firmware** setup page (*Configuration->Admin->Install Firmware*):
  - a. Press and hold the *Sleep* button for 3 seconds to open the *Settings* page.

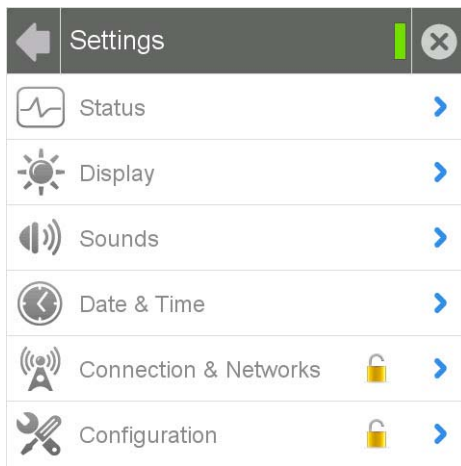

FIG. 26 Settings page

- b. From the *Settings* page, select the *Configuration* page. This may require entering a password.
    - c. From the *Configuration* page, select *Admin*.
    - d. From the *Admin Configuration* page, select *Install Firmware*.
  3. In the *Firmware Installation* page, select **New** to install new firmware from external disk.
  4. The popup page displays the name of the firmware file (for example, "SW5968\_ModeroX\_v2\_103\_52.kit").
  5. Select **Yes**, and follow the directions displayed on the popup.
  6. Once the panel reboots it will perform the firmware upgrade.
- After the upgrade, the unit contains the newly loaded version of firmware.



## Upgrading from Previous Firmware

The MXT-1900L-PAN and MXD-1900L-PAN allow the option to revert the device to the previous firmware run before an upgrade. To upgrade the device from previously loaded firmware:

1. From the *Settings* page, select the *Configuration* page.
2. From the *Configuration* page, select *Admin*.
3. From the *Admin Configuration* page, select *Install Firmware*.
4. In the *Firmware Installation* page, select *Previous*.
5. The *Confirmation Dialog* box (FIG. 27) will ask “Are you sure you want to install the following firmware?” The option to choose **Yes** will be enabled after five seconds. Press **Yes** to load the firmware listed, and **No** to return to the *Firmware Installation* popup window.



FIG. 27 Previous Firmware installation confirmation dialog box

6. If you choose **Yes**, the device will retrieve the files and then reboot.

## Returning to Factory Default Firmware

The MXT-1900L-PAN and MXD-1900L-PAN allow the option to return the device to its original factory default firmware, which may be necessary in certain situations. To return the device to its factory default firmware:

1. From the *Settings* page, select the *Configuration* page.
2. From the *Configuration* page, select *Admin*.
3. From the *Admin Configuration* page, select *Install Firmware*.
4. In the *Firmware Installation* page, select *Factory*.
5. The *Confirmation Dialog* box (FIG. 28) will ask “Are you sure you want to install the following firmware?” The option to choose **Yes** will be enabled after five seconds. Press **Yes** to load the firmware listed, and **No** to return to the *Firmware Installation* popup window.



FIG. 28 Previous Firmware installation confirmation dialog box

6. If you choose **Yes**, the device will retrieve the files and then reboot.

## Upgrading Firmware Via NetLinx Studio

The MXT-1900L-PAN and MXD-1900L-PAN use an Ethernet connection for programming, firmware updates, and touch panel file transfer via NetLinx Studio. If you have access to the panel's network, you may transfer files directly to the panel through NetLinx Studio.



*Firmware upgrades cannot be made through an Ethernet-connected PC to the touch panel, unless that PC is connected to the panel's network. Upgrades **cannot** be made with NetLinx Studio through a USB connection to the panel from a PC. For more information on firmware transfers, please refer to the online help in NetLinx Studio.*

To upgrade firmware via NetLinx Studio:

1. Launch NetLinx Studio and select **Settings > Master Communication Settings** from the Main menu to open the *Master Communication Settings* dialog (FIG. 29).

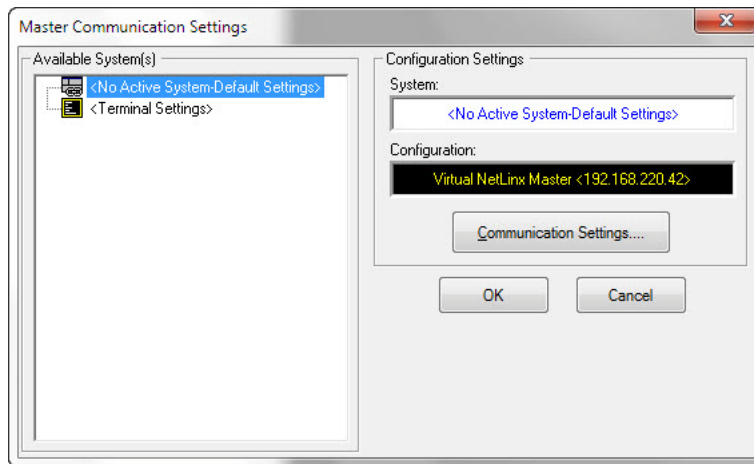

**FIG. 29** Master Communications Settings dialog

2. Click the **Communications Settings...** button to open the *Communications Settings* dialog box (FIG. 30).

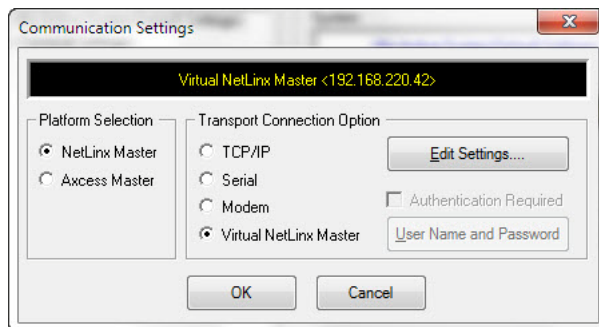

**FIG. 30** Communications Settings dialog box

3. Click on the **NetLinx Master** radio button from the *Platform Selection* section.
4. Click on the **Virtual Master** radio box from the *Transport Connection Option* section to configure the PC to communicate directly with a panel. Everything else, such as the Authentication, is greyed-out because this connection is not going through the Master's UI.

- Click the **Edit Settings** button on the *Communications Settings* dialog to open the *Virtual NetLinx Master Settings* dialog (FIG. 31).

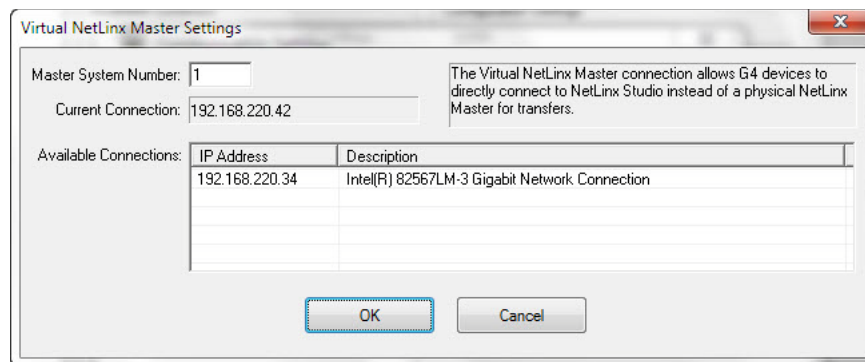

**FIG. 31** Virtual NetLinx Master Settings

- Within this dialog, enter the *Master System number*. The default is **1**.
- In the *Available Connections* section, click on the IP address for the touch panel to select it.
- In the *Virtual NetLinx Master Settings* dialog box, click **OK** to close the box.
- In the *Communications Settings* dialog box, click **OK** to close the box.
- In the *Master Communications Settings* dialog box, click **OK** to save your settings and return to the main NetLinx Studio application.
- Click the **OnLine Tree** tab in the Workspace window to view the devices on the Virtual System. *The default System value is 1.*
- Right-click on the *Empty Device Tree/System* entry and select **Refresh System** to re-populate the list.



*The panel will not appear as a device below the virtual system number, in the Online Tree tab, until both the system number used in step 14 for the Virtual NetLinx Master is entered into the Master Connection section of the System Settings page and the panel is restarted.*

- The OnLine Tree should now display the connection to the device. The *Connection Status Icon* on the device may take up to five seconds to register the connection.

### Viewing devices on the Virtual System

1. After the *Communication Verification* dialog window verifies active communication between the Virtual Master and the panel, click the **OnLine Tree** tab in the Workspace window (FIG. 32) to view the devices on the Virtual System. *The default System value is 1.*
2. Right-click on the System entry (FIG. 32) and select **Refresh System** to re-populate the list. Verify the panel appears in the **OnLine Tree** tab of the Workspace window.

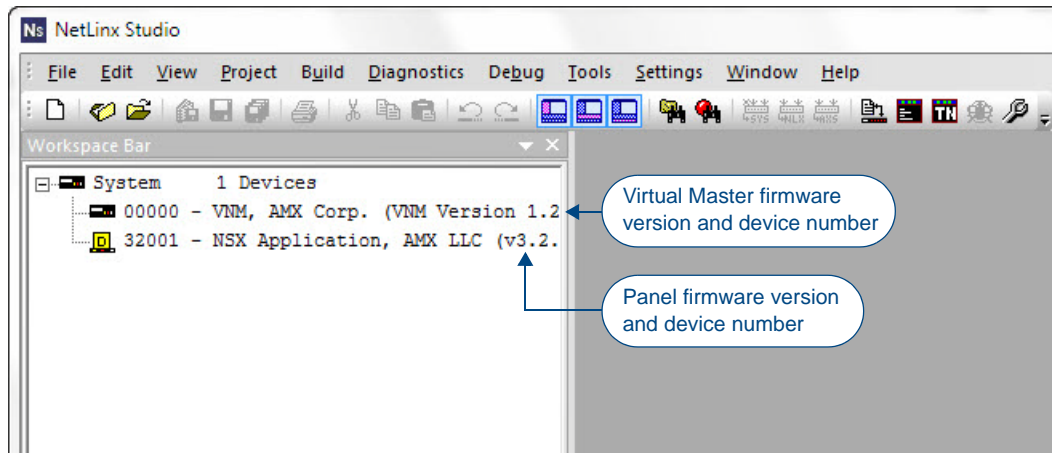

**FIG. 32** NetLinx Workspace window (showing panel connection via a Virtual NetLinx Master)

### Downloading Firmware



*The panel-specific firmware is shown on the right of the listed panel. Download the latest firmware file from [www.amx.com](http://www.amx.com) and then save the Kit file to your computer. Note that each Kit file is intended for download to its corresponding panel. In some cases, several Kit files may be included in a .zip file; extract the .zip file to access the required Kit file.*

1. If the panel firmware version is not the latest available; locate the latest firmware file from [www.amx.com](http://www.amx.com).
2. Click on the desired Kit file link and after accepting the Licensing Agreement, verify download of the Modero Kit file to a known location.
3. Select **Tools > Firmware Transfers > Send to NetLinx Device** from the main menu to open the *Send to NetLinx Device* dialog (FIG. 33). Verify that the panel’s System and Device number values match those values listed within the System folder in the **OnLine Tree** tab of the Workspace window.

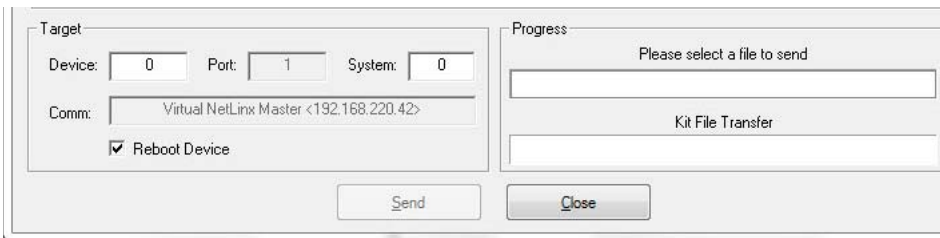

**FIG. 33** Send to NetLinx Device dialog window

4. Select the appropriate Kit file from within the *Browse for Folder* window (FIG. 34).

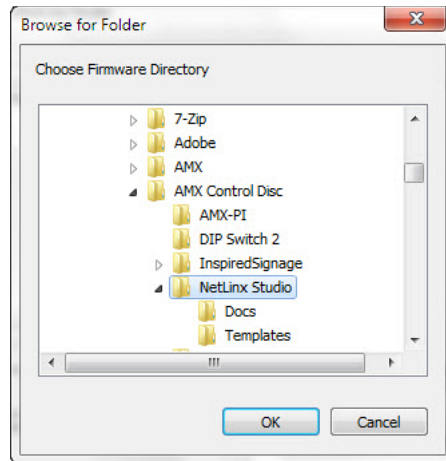

**FIG. 34** Browse for Folder window

5. Select the panel's Kit file from the **Files** section.
6. Enter the **Device** value associated with the panel and the **System** number associated with the Master (*listed in the OnLine Tree tab of the Workspace window*). *The Port field is greyed-out.*
7. Click the **Reboot Device** checkbox if it is not already checked. This causes the touch panel to reboot after the firmware update process is complete.
8. Click **Send** to begin the transfer. The file transfer progress is indicated on the bottom-right of the dialog.
9. After the file transfer is complete, the panel will automatically reboot.
10. After the panel has finished rebooting, right-click the associated System number and select **Refresh System**. This causes a refresh of all project systems, establishes a new connection to the Master, and populates the System list with devices on your particular system.
11. Confirm that the panel has been properly updated to the correct firmware version.



**NOTE**

*Verify you have downloaded the latest firmware file from **www.amx.com** and then save the KIT file to your computer.*



# Appendix: Troubleshooting

## Overview

This section describes the solutions to possible hardware/firmware issues that could arise during the common operation of a Modero touch panel.

### Panel Doesn't Respond To Touches

**Symptom:** The device either does not respond to touches on the touch screen or does not register the touch as being in the correct area of the screen.

If the screen is off:

- *The device may be in Display Sleep Mode.* Press and hold the **Sleep** button to wake up the panel.
- The device may not be connected to power. Verify that the power source is connected to the device and receiving power.

### Panel Isn't Appearing In The Online Tree Tab

1. Verify that the System number is the same on both the NetLinx Project Navigator window and the System Settings page on the device.
2. Verify the proper NetLinx Master IP and connection methods entered into the Master Connection section of the *System Settings* page.

### Can't Connect To a NetLinx Master

**Symptom:** I can't seem to connect to a NetLinx Master using NetLinx Studio.

Select *Settings > Master Comm Settings > Communication Settings > Settings (for TCP/IP)*, and uncheck the "Automatically Ping the Master Controller to ensure availability".

The ping is to determine if the Master is available and to reply with a connection failure instantly if it is not. Without using the ping feature, a connection may still be attempted, but a failure will take longer to be recognized.



NOTE

*If you are trying to connect to a Master controller that is behind a firewall, you may have to uncheck this option. Most firewalls will not allow ping requests to pass through for security reasons.*

When connecting to a NetLinx Master controller via TCP/IP, the program will first try to ping the controller before attempting a connection. Pinging a device is relatively fast and will determine if the device is off-line, or if the TCP/IP address that was entered was incorrect.

If you decide not to ping for availability and the controller is off-line, or you have an incorrect TCP/IP address, the program will try for 30-45 seconds to establish a connection.

### Only One Modero Panel In My System Shows Up

**Symptom:** I have more than one Modero panel connected to my System Master and only one shows up.

Multiple NetLinx Compatible devices can be associated for use with a single Master. If the user does not assign a device number, one will be assigned automatically to the panel. When using multiple panels, different Device Number values have to be assigned to each panel.

1. Press and hold the **Sleep** button to open the *Settings* page.
2. Press the **Protected** button, enter **1988** into the on-screen Keypad's password field, and press **Done** when finished.
3. Enter a Device Number value for the panel into the Device Number Keypad. The range is from 1 - 32000.









It's Your World - Take Control™